



Cali Vinyl™ Plus Flooring

Installation Guide

Floating Click-Lock

(888) 788-2254
www.CaliBamboo.com

Flooring System



Wide+ Click
7-1/8" Wide
Plank Dims:
48" L x 7-1/8" W x 7mm H

Flooring Accessories

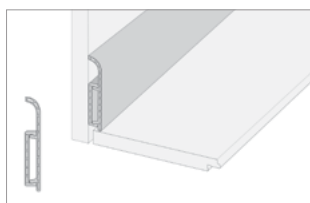

Baseboard

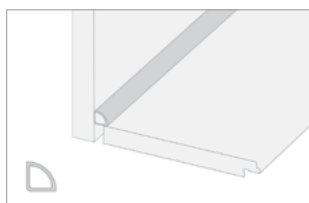

Quarter Round

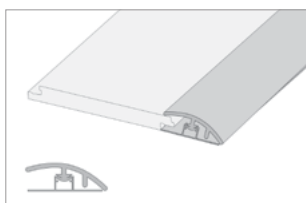

Reducer

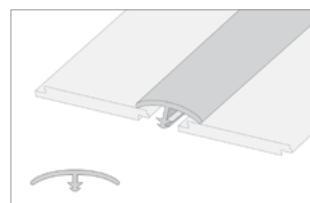

T-Molding

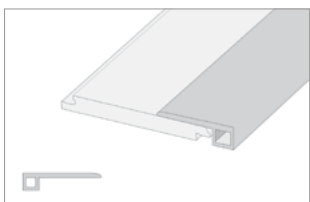

Threshold

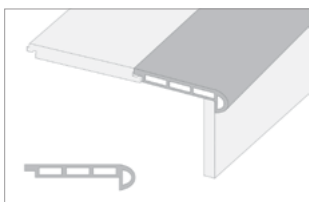

Stair Nosing

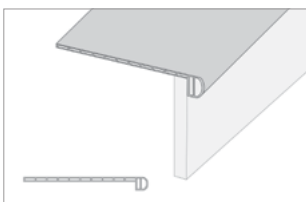

Stair Tread

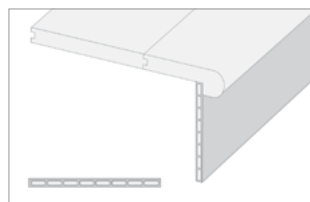

Stair Riser

Before you begin installation, remember to P.A.C.E. yourself with the checklist below. Full installation instructions and maintenance guidelines can also be found online at www.CaliBamboo.com

PACE PREPARE THE SUBFLOOR

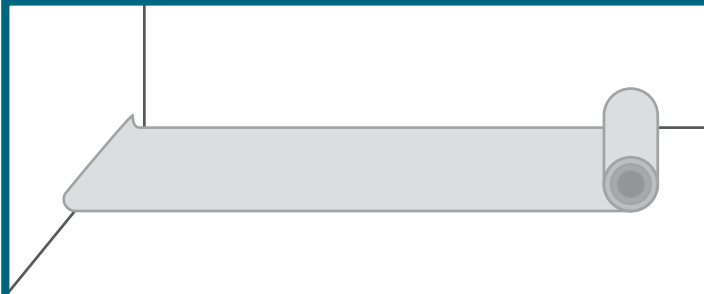

Use 6mil Plastic on Concrete

Make sure the subfloor is flat, level, clean and free of debris. New concrete must be cured for at least 60 days. Test the subfloor moisture prior to installation and apply an appropriate moisture barrier such as 6mil Plastic on concrete subfloors or Silicon Vapor Shield on plywood.

PACE ACCLIMATE FLOORING

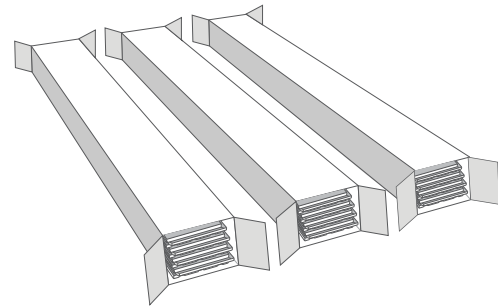

Acclimate Your Vinyl Flooring For 1 to 2 Days

For Vinyl flooring, lay boxes on the floor and only open box ends as shown above. Acclimate your floor as close to the installation area as possible, for 1 to 2 days in normal living conditions.

PACE CONTROL ENVIRONMENT



 32-113°F

Vinyl flooring can be used in areas ranging from 32°F to 113°F.

PACE EXPANSION GAPS

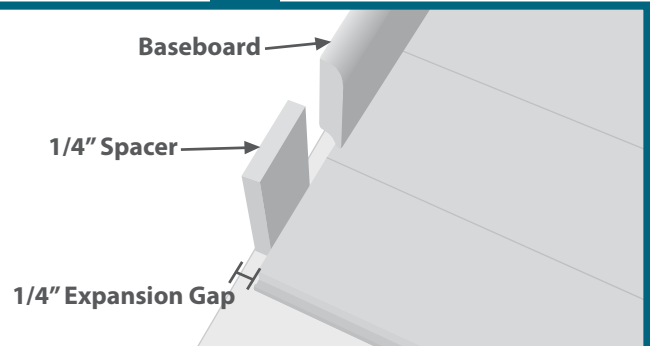

Leave at least 1/4" expansion spaces between flooring and ALL vertical objects (walls, cabinets, pipes, etc.) Large flooring runs may require additional expansion space. **Use transition moldings between rooms and doorways 3 feet or less.** Undercut door jambs and casings to provide adequate expansion space. Do not screw or nail cabinetry or other permanent fixtures to a floating floor.

Floating Click-Lock Luxury Vinyl Plus Plank Installation

Note: Flooring not used for its intended purpose will not be covered under warranty.

Whether you're a pro or DIY homeowner, installing vinyl plank flooring couldn't be easier. No power saws needed; Cali Vinyl flooring scores and snaps with a simple utility knife. Fast and easy floating click-lock installation without all the sawdust and mess! Follow the simple guidelines below and see how easy it is to do it yourself.

- Upon ordering of Vinyl floor materials consider adding an additional 5% to allow for cutting waste and grading allowance.
- Cali Bamboo® flooring is manufactured in accordance with accepted industry standards, which permit manufacturing, grading and natural deficiencies not to exceed 5%. If more than 5% of the material is unusable, do not install the flooring. Immediately contact the distributor/retailer from which the flooring was purchased. No claim will be accepted for materials with visible defects once they are installed. Installation of any material serves as acceptance of the material delivered.
- Installer/Owner assumes all responsibility to inspect all flooring before installation. Planks deemed unacceptable in appearance can be placed in closets, near walls or simply not be used. Pieces with glaring defects that can be seen from a standing position should be cut off or not be used as use constitutes acceptance.
- It is the responsibility of the installer/homeowner to determine if the job site conditions, environmental conditions and sub-floor are acceptable for the installation of Cali Bamboo® Vinyl Plank flooring. Prior to installation, the installer/owner must determine that the jobsite meets or exceeds all applicable World Floor Covering Association Installation Guidelines. Cali Bamboo does NOT warrant against failure resulting from or connected with subfloor, job site damage, or environmental deficiencies after installation. Cali Bamboo makes no warranty or guarantee of the quality of the chosen installer's work or of a particular installation performed by him or her. Cali Bamboo disclaims all liability for any errors or improprieties in the installation of its products by an installer.
- Floor noise is normal and will vary from one installation type to the next. Occasional noise is due to structural movement and may relate to sub-floor type, flatness, deflection, and/or related to the fasteners, changes in environmental conditions, relative humidity and the amount of topside pressure applied to the flooring. For these reasons floor noise is not considered a product or manufacturer defect.
- During installation, it is the installer's responsibility to document all jobsite conditions and measurements including the installation date, site relative humidity, temperature, and subfloor moisture content. This information must be retained by the installer and left with the property owner as a permanent record. For a complete list of points to address prior to installation, refer to the NWFA Jobsite checklist
- Do not install flooring under permanent or fixed cabinetry.
- Never nail or screw anything through a FLOATED floor.

Transport, Storage, Acclimation

- Transport and store cartons in lay down, flat position.
- Stack boxes no more than 8 cartons high. Keep away from direct sunlight
- Room temperature and relative humidity must be consistent with year-round living conditions for at least 5 days prior to installation.
- Due to the nature of Cali Bamboo LVP, typical acclimation is for 24 to 48 hours. Flooring does not need to be taken out of the boxes, just opened at the ends.

Pre-Installation Preparation

Prior to installation, inspect planks in daylight for visible faults/damage. Check if subfloor/site conditions comply with the specifications described in these instructions. If you are not satisfied do not install, and contact your supplier. Cali Bamboo is not responsible for flooring that is installed with visible defects.

Recommended Tools

- Tape measure
- Chalk line
- Utility knife
- Rubber mallet
- Miter saw
- Pencil
- 1/4" spacers
- Table saw
- Double-sided prybar
- Tapping block

Due to the nature of Cali Bamboo Vinyl Plus, it is acceptable to use the score and snap method for your end cuts. It is still recommended to use a table or miter saw for any rip cuts.

Subfloor Requirements

General

- Floating floors can be laid on top of most hard surfaces (e.g. concrete, ceramics, wood)
- Soft subfloors (e.g. carpets) must be removed
- The subfloor must be level – Flat to 3/16” per 10-foot radius
- The subfloor must be clean = Thoroughly swept and free of all debris
- The subfloor must be dry
- The subfloor must be structurally sound

Even though Cali Bamboo Vinyl Plank Flooring is waterproof it is NOT considered a moisture barrier. Hence, we always require laying down a vapor barrier on plywood and a moisture barrier on concrete. Example of:

- Vapor barrier: Silicon Vapor Shield
- Moisture barrier: 6mil plastic

Acceptable Subfloor Types

- CD Exposure 1 plywood (grade stamped US PS1-95)
- OSB Exposure 1 subfloor panels
- Underlayment grade particleboard
- Concrete slab
- Existing wood or laminate floor (cannot have a padding underneath laminate)
- Ceramic tile (must fill in grout lines with a compatible patch compound)
- Resilient tile and sheet vinyl

Wood subfloors must be securely fastened. A best practice is to nail or screw every 6” along joists to avoid squeaking. If leveling is needed, sand down high spots and fill in low spots with a Portland based leveling compound.

Tip: If your plywood, OSB or particle board subfloor is reading higher than 13% MC it is advised to find and correct the source of moisture intrusion before continuing installation. Cali Bamboo is not responsible for any damage caused by moisture intrusion.

Concrete subfloors must be fully cured and at least 60 days old, preferably 90 days old. If leveling is needed, grind down high spots and level low spots with a Portland based leveling compound.

Tip: When laying 6 mil plastic it is always advised to overlap the seams at least 6” and cover all seams with duct tape.

Slabs on or below grade must be free of hydrostatic pressure.

Important: Cali Bamboo Vinyl Plank flooring is waterproof, however moisture intrusions from concrete hydrostatic pressure, flooding, or plumbing leaks, along with high levels of alkalinity, can affect the floor over time. Moisture can also be trapped below the flooring and create mold or mildew. The installer, not Cali Bamboo is responsible for making sure the concrete moisture and alkalinity are suitable prior to installing this floor.

Ceramic Tile, resilient tile and sheet vinyl must be well-bonded to subfloor, in good condition, clean and level. We do not recommend sanding existing vinyl floors, as they may contain asbestos. We do recommend filling any grout lines or embossing with a compatible patch compound. Any damaged caused by skipping this step will not be covered by Cali Bamboo.

Crawlspaces must have a minimum of a 6-mil polyethylene sheeting covering any exposed earth. Crawl spaces must have adequate ventilation and a minimum of 18” of air space between the ground and the floor joist.

Radiant Heat Systems

Cali Bamboo® Vinyl flooring is only recommended for use over radiant heat systems if the special requirements specified by the National Wood Flooring Association are met (please refer to the NWFAs Radiant Heat Guidelines). Ensuring stable job site conditions, subfloor suitability and proper acclimation are especially important when installing over a radiant heat system. It is the responsibility of the installer to ensure that the recommended environmental conditions are met for installation. Refer to your radiant heat system manufacturer to determine its compatibility with bamboo flooring, and to learn the specific requirements for installation.

- Because of the wide variety of systems on the market (Hydronic, embedded in concrete, electrical wire/coil, heating film/mat) each with its own features and applications it is recommended that the user consult with the radiant heating provider for best practices, installation methods and proper subfloors.
- With Cali Vinyl the floating installation method is the only method recommended for use with radiant heat systems.
- Radiant heat system must be turned on and in operation for at least 3 days before installation.

- The flooring must be acclimated per Cali Bamboo's Vinyl flooring acclimation instruction (<https://www.calibamboo.com/installing-vinyl-plank-flooring/>) over the radiant heat with the system turned on throughout the acclimation timeframe.
- The system must be turned down to 65°F and maintained 24 hours prior to installation.
- Once install is complete, turn system back on and slowly bring back up to normal operating temperature over a period 4-5 days.
- Floor should never be heated over 85°F. Consult with your radiant heating system manufacturer to successfully limit the maximum temperature.
- Always remember that rugs placed over radiant heated flooring can increase the surface temperature in that area by 3°-5°F degrees.
- Relative Humidity must be maintained between 20-80%.
- When turning off the radiant heat system it must be turned down slowly at a rate of 1.5° degrees per day. You should never just turn the system off.
- For additional information on radiant heating systems please refer to <http://www.radiantpanelassociation.org> or the NWFA's Radiant Heat Guidelines.

Installation of Cali Vinyl™ Flooring by Cali Bamboo®

Before laying: Measure the room at right angle to the direction of the planks. Planks in the final row should be at least 1/3 the width of a plank. Due to this rule, planks in the first row can be cut to smaller size. Shuffle planks in order to obtain a pleasant blend of shades. Lay planks preferably following the direction of the main source of light. We recommend laying on wooden floors crossways to the existing floorboard. You should never nail or screw planks to the subfloor.

- Floor should be installed from several cartons at the same time to ensure good color, shade and appearance. Cali Bamboo Vinyl Plank will have 11+ patterns for each product.

Expansion gaps: Even though Cali Bamboo Vinyl Plank will have very minimal expansion and contraction it is still required to leave 1/4" expansion space around the perimeter as well as all fixed objects (tile, fireplace, cabinets).

- If the installation area exceeds 30 feet, a greater expansion space is required; approximately 1/16" for every additional ten (10) feet. If the floating installation flows into other rooms, a T-molding must be used in doorways and openings between rooms (halls, archways, etc.) to allow separate areas to move without interference.
- To cover your expansion space, Cali Bamboo carries matching bamboo flooring moldings that include reducers, t-moldings, baseboards, quarter rounds, and thresholds. Matching stair parts are also available; including stair nosing, treads and risers. Please visit Cali Bamboo's Flooring Accessories webpage.

Tip: When installing around pipes, drill the hole 3/4" larger than the diameter of the pipes.

Installing the first row:

Measure the room at right angle to the direction of the planks. Planks in the final row should be at least 1/3 the width of a plank. Due to this rule, planks in the first row can be cut to smaller size. Shuffle planks in order to obtain a pleasant blend of shades. Lay planks preferably following the direction of the main source of light. We recommend laying on wooden floors crossways to the existing floorboard. You should never nail or screw planks to the subfloor.

1. Starting from the left with the tongue-side facing the wall, carefully place the first board in place, using spacers to leave a 1/4" expansion gap between wall and edges of the plank.
2. Install the second piece by aligning the butt end with the end of the first piece at a 45 degree angle. Softly push the second piece down until the tongue and groove lock together to secure the joint on the ends. Continue in this manner until reaching the final board in the first row.
3. Cut the final board piece to length and install it in the same manner as the previous piece.



Next Steps:

1. If the cut plank is at least 8" in length, it can be used as a starter piece in another row. If the cut plank is shorter than 8" do not use it. Instead, begin with a new board that is at least 8" in length and allows 8" between the end joints on the adjacent planks.
2. Position the first board in place by angling it up slightly, pushing forward and interlocking the side tongue. The long side of the plank should fit snug with no gapping.
3. Install the second plank in the second row by partially disengaging the first plank for the purpose of locking the butt ends of the first and second plank. Once this is done repeat step 2.
4. Carefully inspect the long edge and short ends of the plank for any gapping before moving on to the plank. If you notice a gap, STOP, and reinstall the board to ensure a snug fit.
5. Install the remaining boards and rows in the same manner.
6. Cut the last board to size.
7. Whenever practical, use cut pieces from previous rows as the starter board to reduce waste, however, it is a best practice when doing this to not create a repeating pattern. For a natural look rows and patterns should be staggered.
8. Maintain proper spacing (at least 8") between end joints for best appearance.



Installing the Final Row:

1. The last row may need to be cut lengthwise (ripped). Make sure ripped piece is at least 1/3 the size of the overall width of the plank.
2. Place the last row of boards to be fit on top of the last row of installed boards. Use a piece of plank or tile as a scribe to trace the contour of the wall.
3. Mark where the board will be cut. If the fit of the wall is simple and straight, simply measure for the correct fit and cut.
4. After boards are cut, position boards and tap all joints (long AND short ends) with the rubber mallet.



After Install/Floor Care Maintenance:

- For Cleaning, we recommend dry or damp mopping as needed using Bona Stone Tile & Laminate cleaner or similar.
- Do not use anything abrasive or harsh chemicals to clean the floor. Never use any of the following products on your floor: ammonia-based cleaners, mineral spirits, acrylic finishes, wax-based products, detergents, bleach, polishes, oil soap, abrasive cleaning soaps, acidic materials such as vinegar.
- Never apply wax treatments or top coats to the floor.
- Do not drag furniture across the floor, use felt pads on chair and furniture legs.
- Keep pet's nails trimmed to avoid excess scratching.
- Sweep or vacuum the floor regularly to remove loose dirt. Do NOT use vacuums that use a beater bar or turn beater bar off.
- Place quality walk-off mats at all entrances to retain tracked in dirt, grit and moisture, never use latex or rubber backed mats as they can permanently stain the floor.
- Area rugs are also recommended in front of kitchen sinks and in high traffic areas.
- Although the Cali Vinyl Plank Flooring is water proof, it is still a best practice to avoid excessive moisture on the floor. Therefore, we recommend soaking up spills immediately using a dry towel or dry mop.
- Limit direct sunlight on floor by using curtains and blinds in areas that are exposed to high UV rays.
- Heating units or non-insulated ductwork close to the flooring or subfloor may cause "hot spots" which must be eliminated prior to installation.
- Heavy furniture (500+ lbs.) may obstruct the free, natural movement of a floated floor. Restricting this movement in certain areas can lead to problems such as buckling or separation when the floor experiences natural expansion and/or contraction.