



Cali Vinyl® Plus Flooring



P.A.C.E. Pre-Installation Checklist(s)

(888) 788-2254
www.CaliBamboo.com

CALI VINYL PLUS: Floating Click-Lock Luxury Vinyl Plank Installation

Before you begin installation, remember to P.A.C.E. yourself with the checklist below. Full installation instructions and maintenance guidelines can also be found online at www.CaliBamboo.com

PACE PREPARE THE SUBFLOOR



Use 6mil Plastic on Concrete

Make sure the subfloor is flat, level, clean and free of debris. New concrete must be cured for at least 60 days. Test the subfloor moisture prior to installation and apply an appropriate moisture barrier such as 6mil Plastic on concrete subfloors or Silicon Vapor Shield on plywood.

PACE ACCLIMATE FLOORING

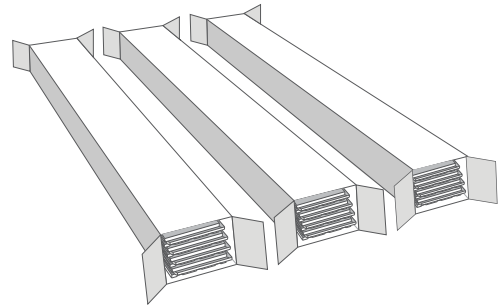

Acclimate Your Vinyl Flooring For 1 to 2 Days

For Vinyl flooring, lay boxes on the floor and only open box ends as shown above. Acclimate your floor as close to the installation area as possible, for 1 to 2 days in normal living conditions.

PACE CONTROL ENVIRONMENT



 32-113°F

Vinyl flooring can be used in areas ranging from 32°F to 113°F.

PACE EXPANSION GAPS

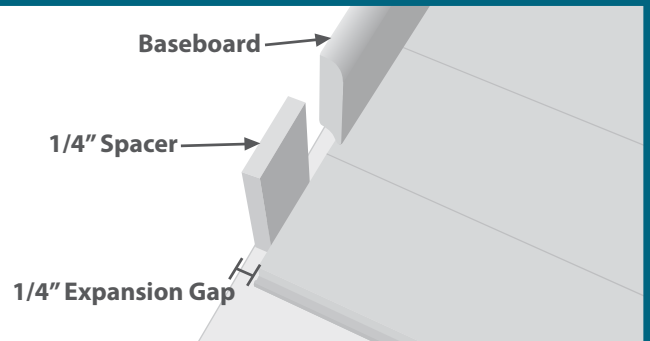

Leave at least 1/4" expansion spaces between flooring and ALL vertical objects (walls, cabinets, pipes, etc.) Large flooring runs may require additional expansion space. **Use transition moldings between rooms and doorways 3 feet or less.** Undercut door jambs and casings to provide adequate expansion space. Do not screw or nail cabinetry or other permanent fixtures to a floating floor.



CALI VINYL PLUS: Glue Down Luxury Vinyl Plank Installation

Before you begin installation, remember to P.A.C.E. yourself with the checklist below. Full installation instructions and maintenance guidelines can also be found online at www.CaliBamboo.com

PACE PREPARE THE SUBFLOOR

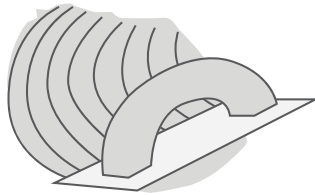

Required Adhesive will act as Moisture Barrier

Make sure the subfloor is flat, level, clean and free of debris. New concrete must be cured for at least 60 days. Test the subfloor moisture prior to installation and apply an appropriate moisture barrier on concrete subfloors or a vapor barrier on plywood. (Required adhesive will act as moisture/vapor barrier.)

PACE ACCLIMATE FLOORING

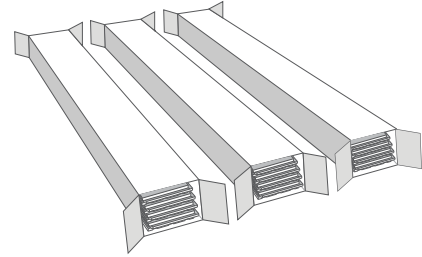

Acclimate Your Vinyl Flooring For 1 to 2 Days

For Vinyl flooring, lay boxes on the floor and only open box ends as shown above. Acclimate your floor as close to the installation area as possible, for 1 to 2 days in normal living conditions.

PACE CONTROL ENVIRONMENT



 32-113°F

Vinyl flooring can be used in areas ranging from 32°F to 113°F.

PACE EXPANSION GAPS

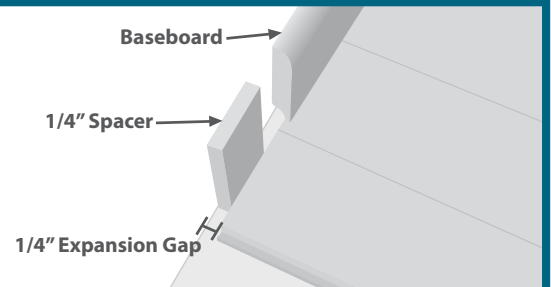

Leave at least 1/4" expansion spaces between flooring and ALL vertical objects (walls, cabinets, pipes, etc.) Large flooring runs may require additional expansion space. **Transition pieces become optional with Glue-Down method.** Undercut door jambs and casings to provide adequate expansion space. Cali Bamboo® does not recommend screwing or nailing cabinetry or other permanent fixtures to flooring.

